

## TEHNIČKI PODACI

Model: ..... DHL1704  
 Tip Grla: ..... LED  
 Napon: ..... 5V /220V  
 Frekvencija: ..... 50Hz  
 Snaga: ..... 2.2W  
 Stepen Zaštite: ... IP65

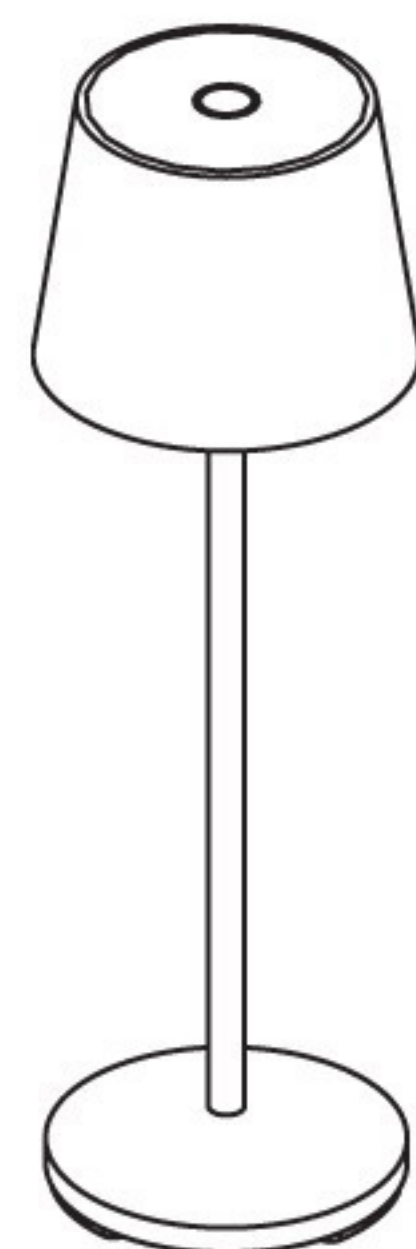

## UPUTSTVO ZA UPOTREBU

### Uključivanje na dodir

Memorija jačine svetla.  
 Svaki put kada uključite lampu jačina svetla je ista kao prethodno podešavanje.



### Isključivanje na dodir

Vreme dodira - manje od 0.5sek

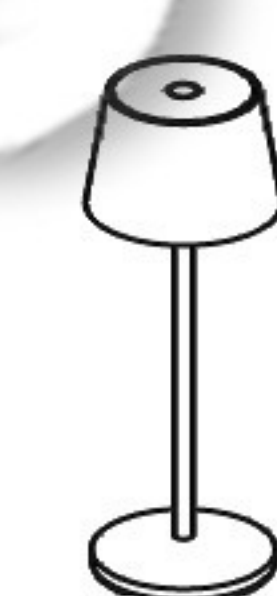

### POSTEPENO DIMOVANJE

Funkcioniše samo kada je svetlo upaljeno

Vreme dodira - duže od 0.5sek

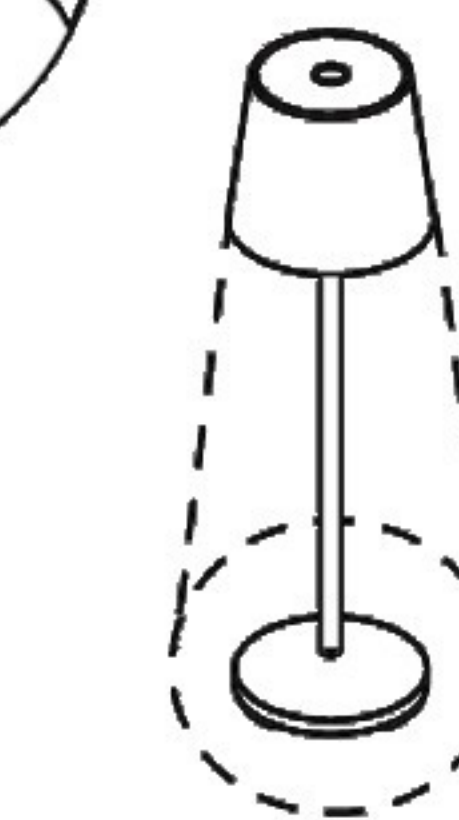
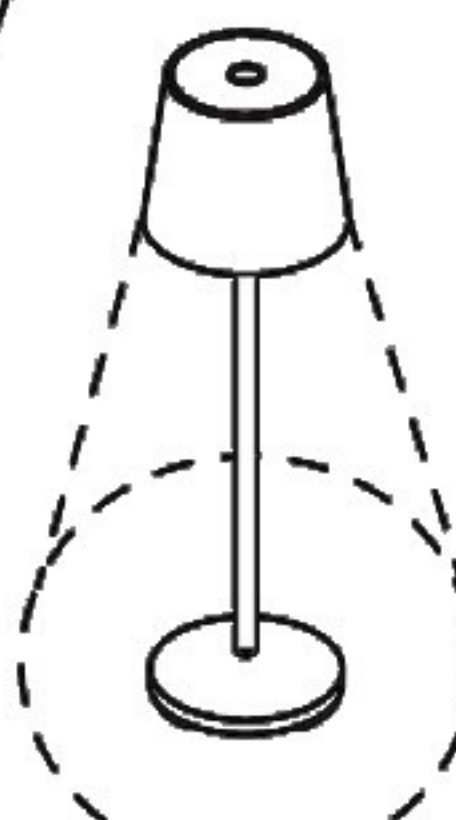

### PROMENA BOJE SVETLA

Funkcioniše samo kada je svetlo ugašeno

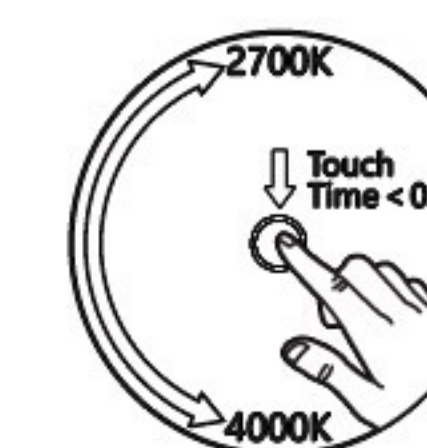
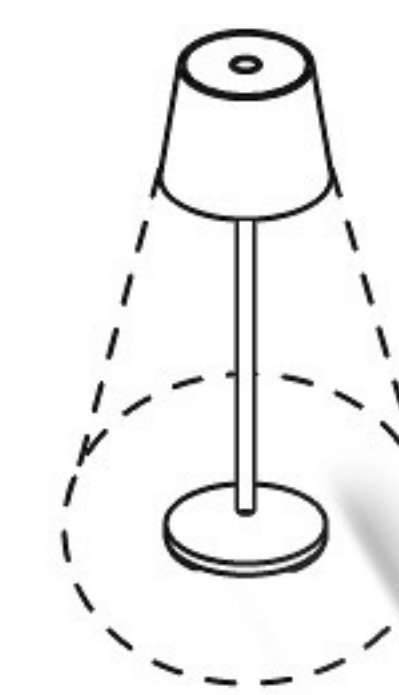
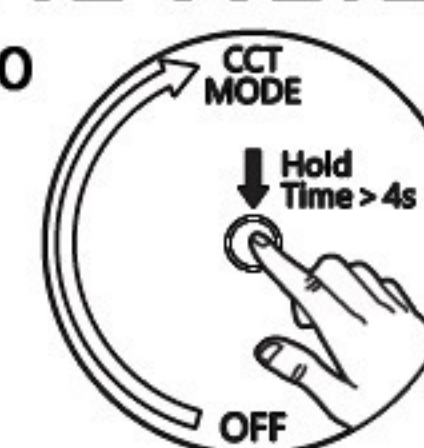

Vreme dodira - kraće od 0.5s



Vreme dodira - duže od 4s

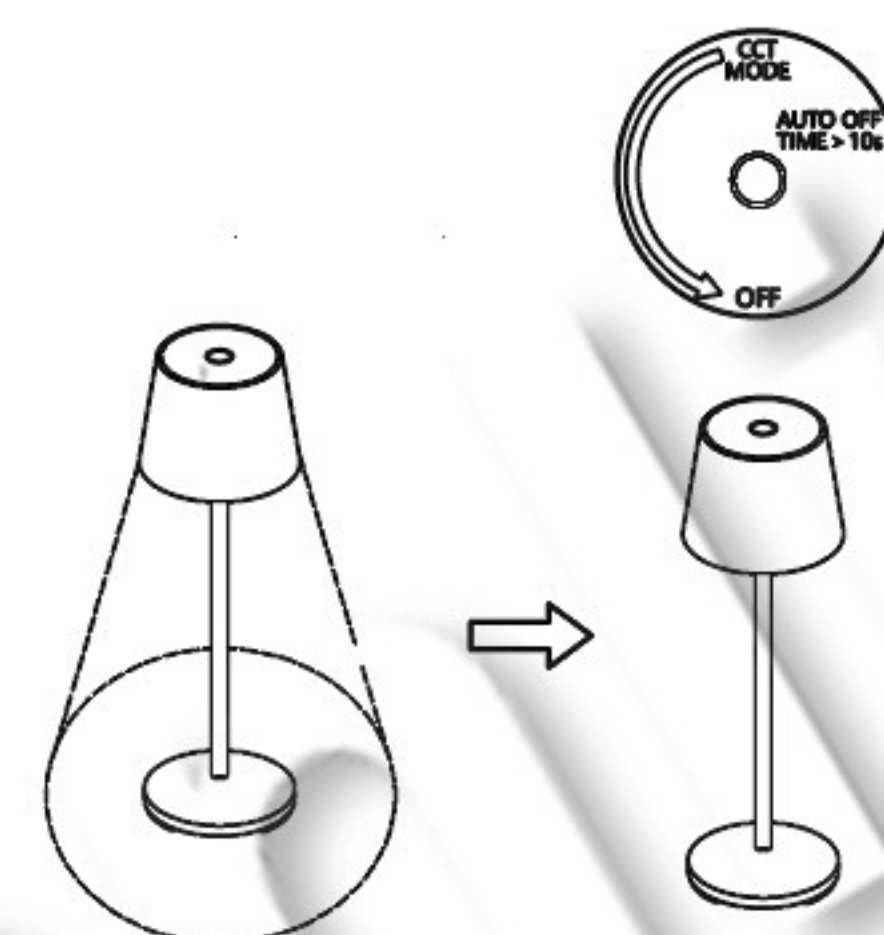

Ukoliko nema komande u okviru 10s, lampa će automatski izaći iz opcije promene boje svetla.

### PUNJENJE

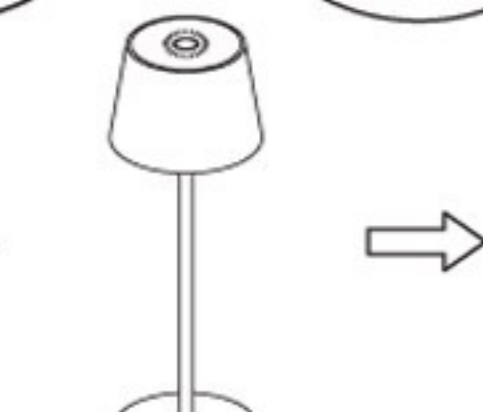
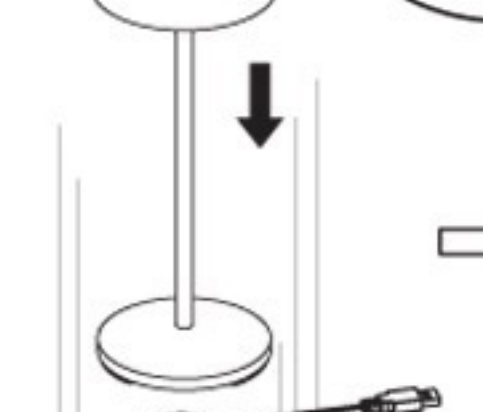
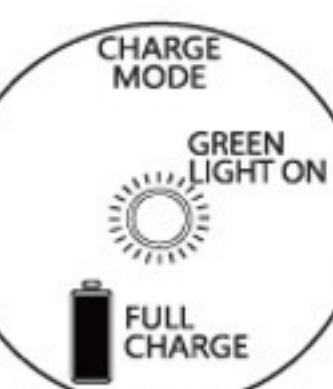
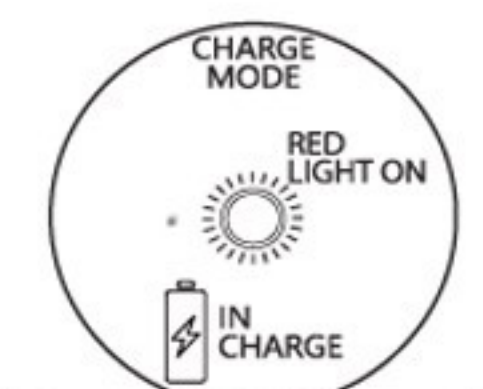
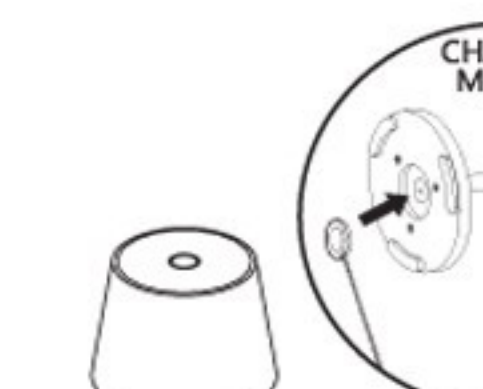
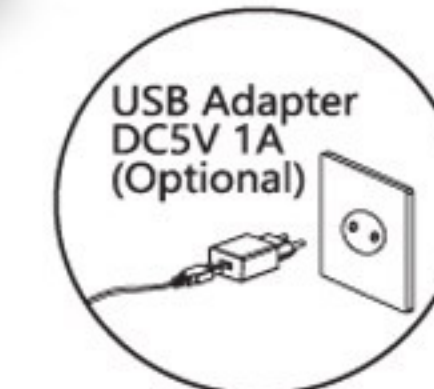

MAX 6 HOURS

6h (potpuno napunjena)

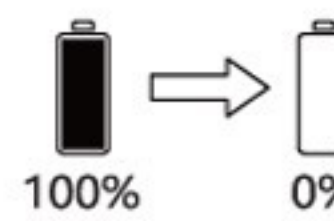

100% 0%

9h (100% intenzitet svetla)



## MERE BEZBEDNOSTI I OPREZA

Pre upotrebe obavezno pažljivo pročitati uputstvo

Opasnost od strujnog udara

- Pre instalacije ili zamene obavezno isključiti dovod struje.
- Instalaciju treba da uradi kvalifikovani električar.
- Ne čistiti vodom i mokrim predmetima.

Opasnost od povreda

- Ne dirati sijalicu golim rukama dok radi i dok se potpuno ne ohladi.
- Ne koristiti preteranu silu prilikom montaže.



IP65

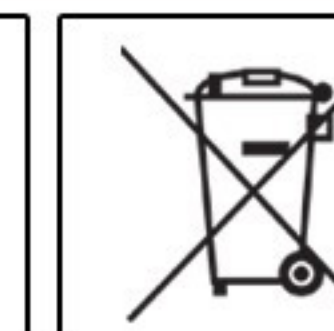
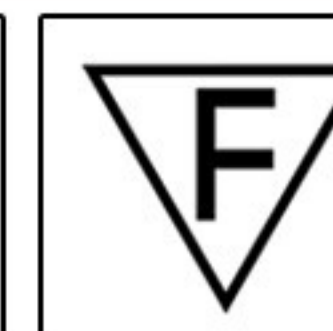

MAX...W

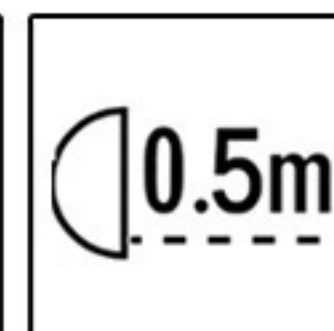

0.5m

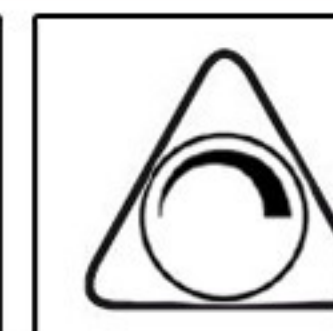

Ovo uputstvo, niti bilo koji njegov deo, ne sme se umnožavati niti na bilo koji način koristiti, prevoditi, adaptirati ili vršiti bilo kakve prepravke teksta, slika ili znakova bez saglasnosti društva XENON-LIGHT d.o.o. Beograd, koje zadržava sva prava na istom.